

Compact multi-channel computer controlled high voltage array PSA-03

1 description

The PSA-03 is a compact multi-channel high voltage power supply designed to drive an array of photomultipliers. The PSA-03 uses high performance circuitry to produce 20 independently programmable highly stable, low noise outputs.

Each HV output is ideally suited to drive a voltage divider, which can be tailored to meet the specific requirements of the photomultiplier. The PSA-03 can be used with 3rd party voltage dividers, or dividers provided by Sens-Tech.

The PSA-03 may be computer controlled using the software provided. The software can set the voltage of each channel and provide real-time monitoring of voltage and current at each channel output. Alternatively, the PSA-03 can operate in stand-alone mode without the need for computer control.

The PSA-03 can be daisy-chained with other PSA-03 units to support a very large array of photomultipliers, all controlled from the same computer. In addition, the PSA-03 can be daisy chained with a Sensor Array, enabling the same computer to monitor a variety of ancillary signals, such as temperature or current – the Sensor Array datasheet is available separately.

2 applications

The PSA-03 is suitable for the following applications:

- security systems
- high energy physics
- industrial processing
- mineral sorting

3 features

- Compact size (19" x 1U x 220mm deep)
- High efficiency, low loss
- Highly stable output
- Computer controlled or stand-alone mode
- Real-time voltage and current monitoring of HV outputs
- Fast shutdown
- Status indicators showing power on, HV on and data activity
- Can be daisy chained with other PSA-03 units to create very large arrays at minimal cost

4 benefits

- fast set up time for large arrays
- real time monitoring of large arrays
- additional channels can be retro fitted to cater for expansion
- ability to monitor ancilliary signals

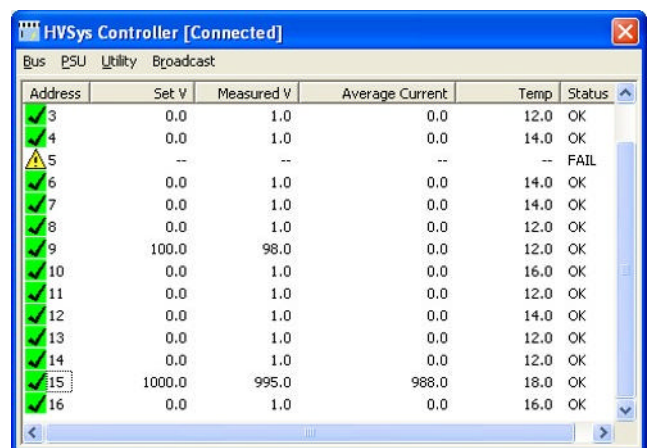
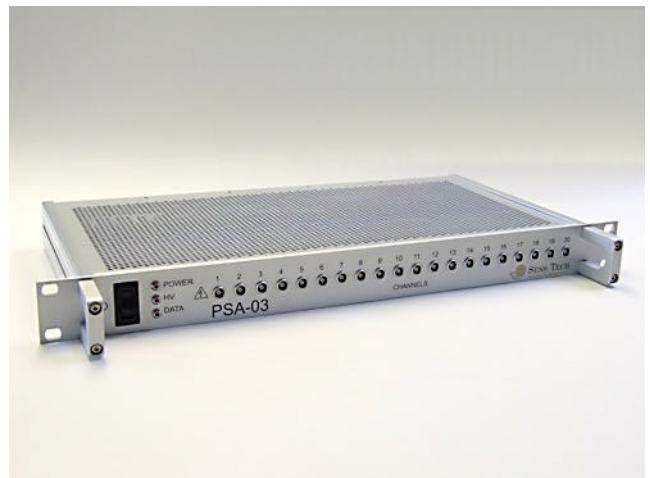

Address	Set V	Measured V	Average Current	Temp	Status
3	0.0	1.0	0.0	12.0	OK
4	0.0	1.0	0.0	14.0	OK
5	--	--	--	--	FAIL
6	0.0	1.0	0.0	14.0	OK
7	0.0	1.0	0.0	14.0	OK
8	0.0	1.0	0.0	12.0	OK
9	100.0	98.0	0.0	12.0	OK
10	0.0	1.0	0.0	16.0	OK
11	0.0	1.0	0.0	12.0	OK
12	0.0	1.0	0.0	14.0	OK
13	0.0	1.0	0.0	12.0	OK
14	0.0	1.0	0.0	12.0	OK
15	1000.0	995.0	988.0	18.0	OK
16	0.0	1.0	0.0	16.0	OK

5 specification

general	
input voltage range	+24V to +48V
input current at full load	2.5A max.
input protection	polarity reversal
output protection	short circuit
number of HV output channels	20
HV output (per channel)	
output voltage range	0V to +1800V programmable
output resolution	0.5V
output current	0.5mA max. per channel
output ripple	< 0.001%
output temperature coefficient	tbd
line regulation	tbd
load regulation	tbd
monitor (per channel)	
voltage monitor	0V to 1800V
voltage monitor resolution	0.5V
current monitor	0µA to 500µA
current monitor resolution	1µA
temperature rating	
operating temperature	0 to 40°C
storage temperature	-10 to 50°C

6 outline drawing (mm)

All dimensions in millimetres.

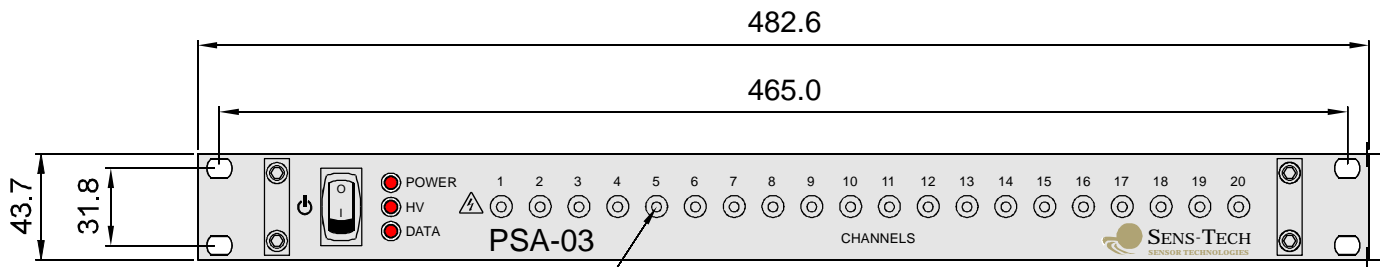
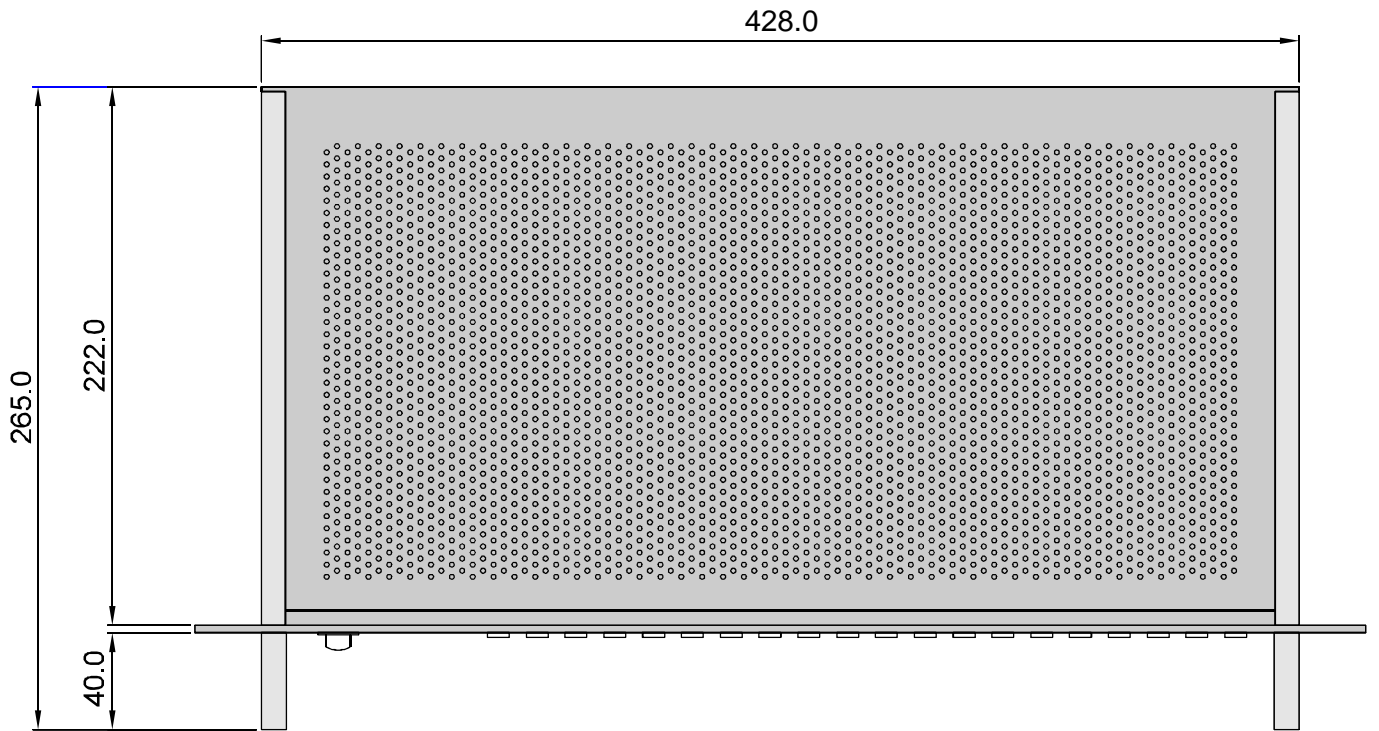

Lemo socket type
ERA.0S.250.CTL

7 system configuration

Front

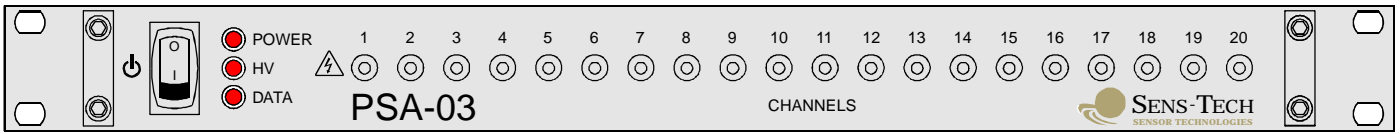

Rear

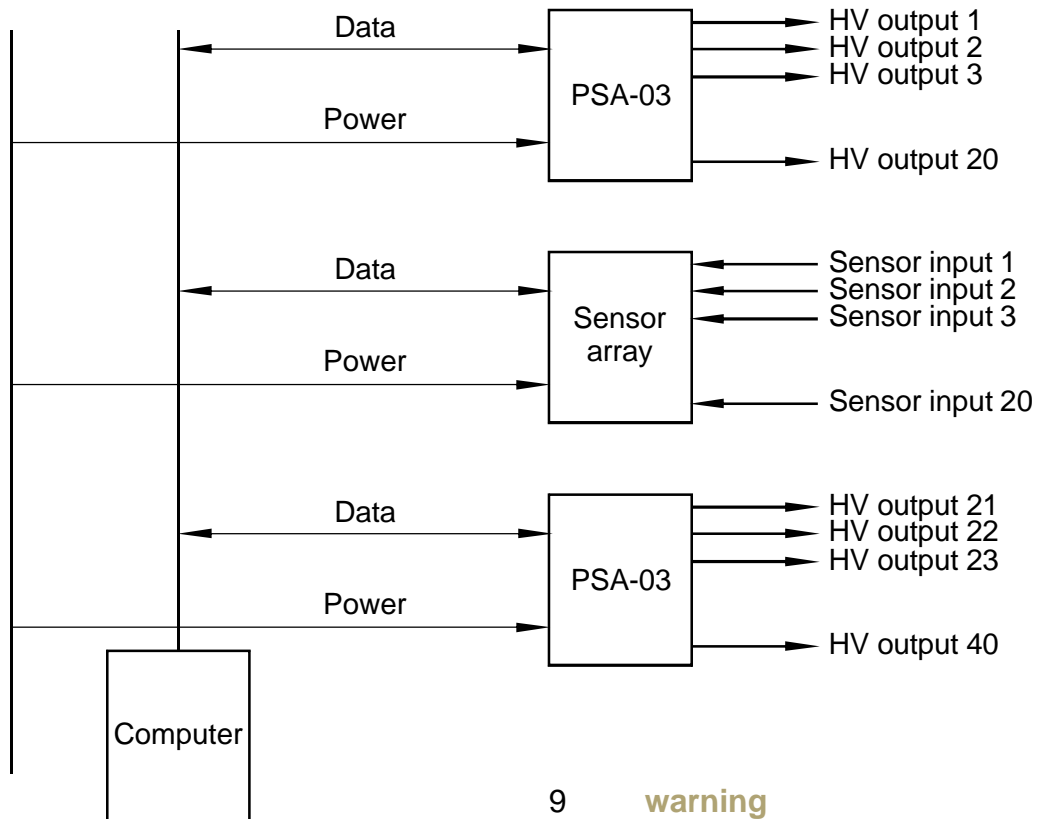
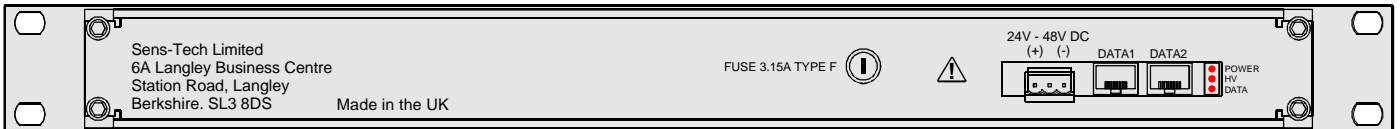

9 warning

High voltages generated by these products present an electrical shock hazard and appropriate precautions must be taken. They must be installed by qualified personnel and operated within the specified ratings.

Do not operate outside the ratings limit. This may result in loss of performance or permanent damage to the PSA-03.

8 ordering options

- cased or open-frame
- HV output: chassis mounted connectors, cable mounted connectors or flying leads

Sens-Tech Limited
6A Langley Business Centre,
Station Road, Langley
Berkshire, SL3 8DS, UK
tel: +44 (0)1753 214714
fax: +44 (0)1753 214715
e-mail: info@sens-tech.com

The company reserves the right to modify these designs and specifications without notice. Developmental devices are intended for evaluation and no obligation is assumed for future manufacture. While every effort is made to ensure accuracy of published information the company cannot be held responsible for errors or consequences arising therefrom.

an ISO 9001 registered company
www.sens-tech.com



© Sens-Tech Limited, 2010
DS_PSA-03 issue 4
22 November 2010